

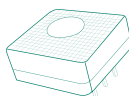

Total Organic Volatile Organic Compound Gas Module 0~2000ppm

TB600C-TVOC-2000

Technical Specification



Printed Solid Polymer Electrochemical Gas Technology

Small Size | Long Life | Low Cost | High Accuracy | Fast Response | Little Power Consumption

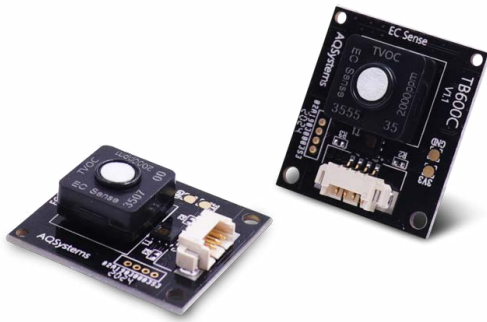

- ☞ High-precision environmental monitoring application;
- ☞ Can react to more than 300 types of TVOC gas;
- ☞ Long life, stable detection and high reliability;
- ☞ New microcircuit design, strong anti-electromagnetic interference ability;
- ☞ Fast response, fast return to zero, plug and play;
- ☞ Independent temperature and humidity digital sensors, combined with intelligent algorithms, have stronger environmental adaptability, more accurate detection and long-term stability;
- ☞ Small size and low power consumption.

Product Overview

TB600C series TVOC module combines various high-precision sensing technologies. The gas sensor is the small-in-size Solid Polymer Electrochemical Sensor from EC Sense, detecting very low concentrations of gases accurately and reliable. The module serves a UART digital output for ease of use, eliminating the need for customers to understand the sensor application and the tedious work of calibration.

Application

- ☞ Industrial process TVOC monitoring
- ☞ Factory-level TVOC emissions monitoring
- ☞ Industrial TVOC waste gas treatment monitoring application
- ☞ Sewage treatment environment application testing
- ☞ TVOC detection for landfill and disposal environment
- ☞ TVOC monitoring application for industrial storage environment
- ☞ Smoke emission monitoring, etc.



Principle

Solid polymer electrochemical technology is a revolutionary innovation in the field of electrochemical detection. This technology is based on the principle of electrochemical catalytic reaction, detecting the output signals of the electrochemical reactions of different gases, and accurately measuring the gas concentration through the signal.

The sensor consists of three electrodes in contact with the electrolyte. A typical electrode consists of a large surface area precious metal and other materials. The electrode, electrolyte and the surrounding air are in contact, and the gas diffuses through the back of the porous membrane into the working electrode of the sensor. At this electrode, the gas is oxidized or reduced, and this electrochemical reaction causes a current to flow through the external circuit.

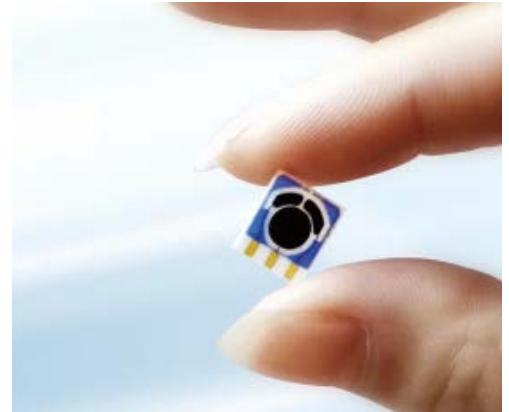

Features

- ☞ High accuracy and long life
- ☞ Fast response speed, fast return to zero, plug and play
- ☞ Good anti-toxicity
- ☞ Easy to use, UART digital signal output
- ☞ German sensors are durable and reliable
- ☞ Excellent accuracy, repeatability, linearity and consistency
- ☞ No zero drift
- ☞ Strong anti-electromagnetic interference ability
- ☞ With fixed mounting holes for easy installation
- ☞ Sleep design for low power IOT applications
- ☞ Independent temperature and humidity digital sensor output
- ☞ RoHS environmental design

Linearity

Temperature environment: 26°C ; Humidity environment: 55%; Air chamber space: 0.03m³; Ventilation flow of air distribution system: 4000sccm



Test result: 0-300ppm linear error $\leq \pm 3\%$; 300-1000ppm linear error $\leq \pm 5\%$;

Cross Sensitivity

| Gas | Molecules formula | Concentration (ppm) | Response (ppm) |
|---|---|---------------------|----------------|
| Isobutylene | C ₄ H ₈ | 5 | 5 |
| Ethylene | C ₂ H ₄ | 5 | 3.16 |
| Formaldehyde | HCHO | 5 | 6 |
| Methyl mercaptan | CH ₄ S | 5 | 7 |
| Ethylene oxide | C ₂ H ₄ O | 5 | 3.83 |
| Ethanol | C ₂ H ₆ O | 5 | 1.83 |
| Carbon disulfide | CS ₂ | 5 | 1.23 |
| Dimethyl Disulfide | C ₂ H ₆ S ₂ | 2 | 6.8 |
| Methanol | CH ₃ OH | 5 | 5.95 |
| Methyl sulfide | C ₂ H ₆ S | 5 | 8.97 |
| Styrene | C ₈ H ₈ | 0.5 | 7.5 |
| Benzene | C ₆ H ₆ | 5 | 1.1 |
| Toluene | C ₇ H ₈ | 5 | 0.81 |
| O-xylene | C ₈ H ₁₀ | 5 | 0.58 |
| Gasoline volatilization (dimensionless) | Aliphatic hydrocarbons, cycloalkanes, aromatic hydrocarbons | / | Good Response |
| Dining lampblack (dimensionless) | Unsaturated hydrocarbons | / | Good Response |
| Acrylonitrile | C ₃ H ₃ N | / | Good Response |
| Acetylene | C ₂ H ₂ | / | Good Response |
| Butadiene | C ₄ H ₆ | / | Good Response |
| Formic acid | HCOOH | 5 | 5.36 |
| Acetic acid | CH ₃ COOH | 5 | 1.1 |
| Carbon monoxide | CO | 5 | 3.38 |
| Hydrogen chloride | HCl | 5 | 0.27 |
| Hydrogen cyanide | HCN | 5 | 0.36 |
| Ammonia | NH ₃ | 5 | 1.5 |
| Hydrogen | H ₂ | 5 | 1.15 |
| Trimethylamine | C ₃ H ₆ N | 5 | 0.65 |
| Nitrogen dioxide | NO ₂ | 5 | 1.86 |

Zero Drift Testing (More than 12 hours)

Temperature environment: 26 °C ; Humidity environment: 55%; Environmental space: 0.03m³ air chamber; Ventilation flow of air distribution system: 4000sccm

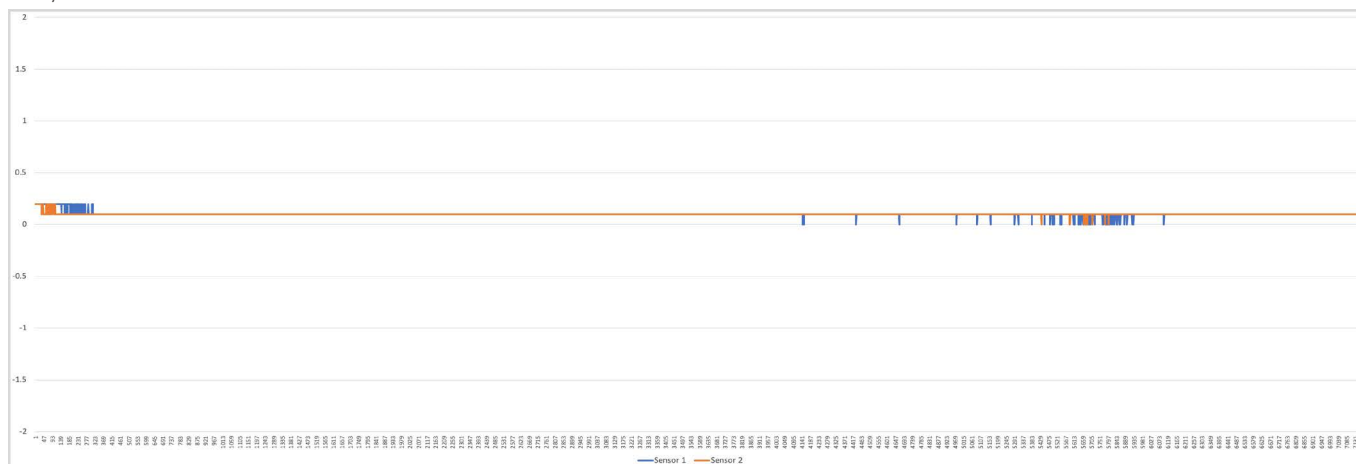

Test result: 12 hours clean air test, zero drift <0.3ppm (0-2ppm is the normal zero fluctuation range);

Sensitivity Drift Testing

Temperature environment: 26°C ; Humidity environment: 55%; Air chamber space: 0.03m³; Gas flow of gas distribution system: 4000sccm

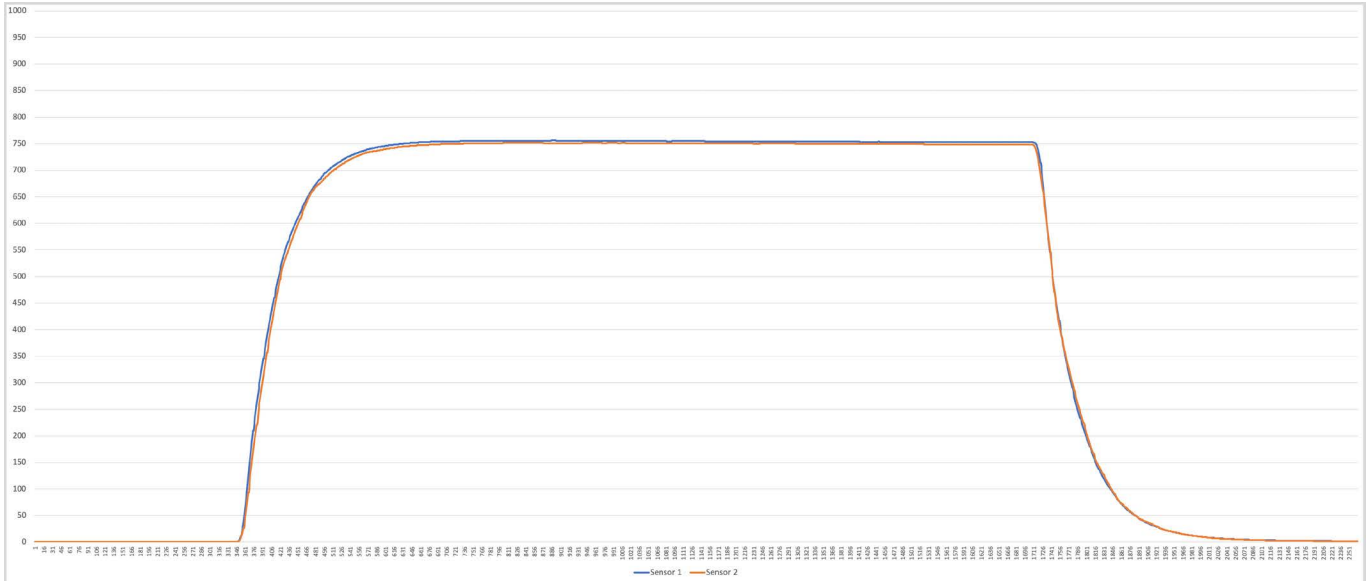

Test result: 2 hours ventilation, range drift <0.5ppm; (2000ppm ±2% of full scale is the normal range);

Repeatability

Temperature environment: 26°C ; Humidity environment: 55%; Gas chamber space: 0.03m³ Gas flow of gas; Distribution system: 4000sccm

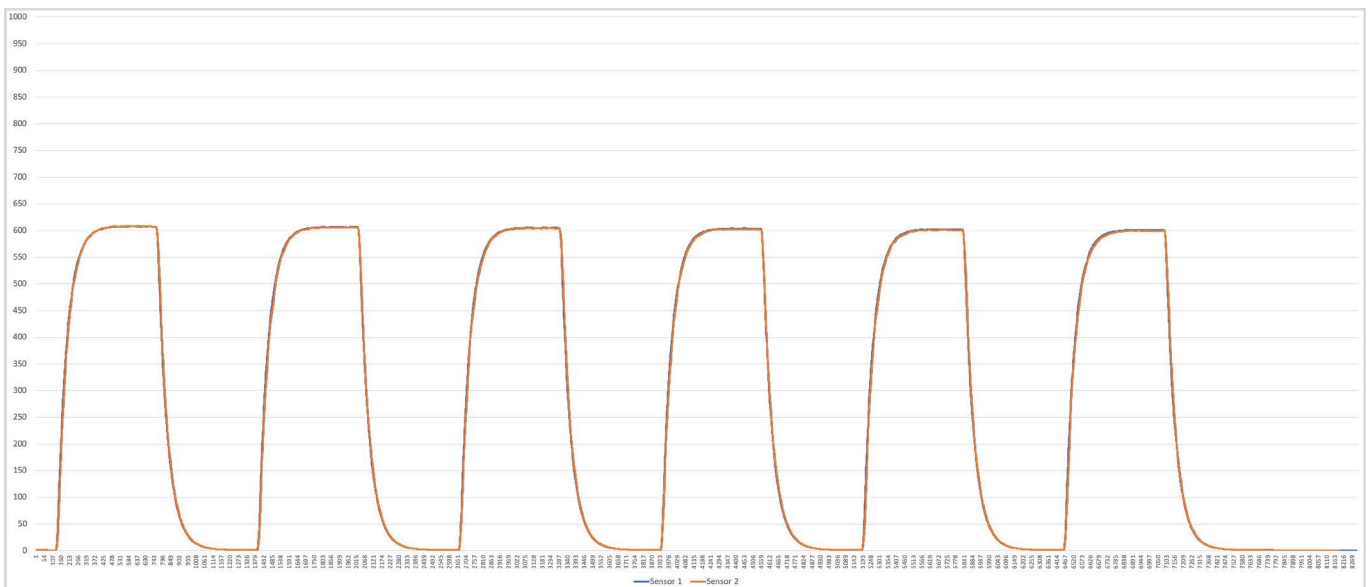

The test results show that the repeatability error range is <5ppm (2000ppm ± 1% of full scale is the normal range);

Structure Diagram

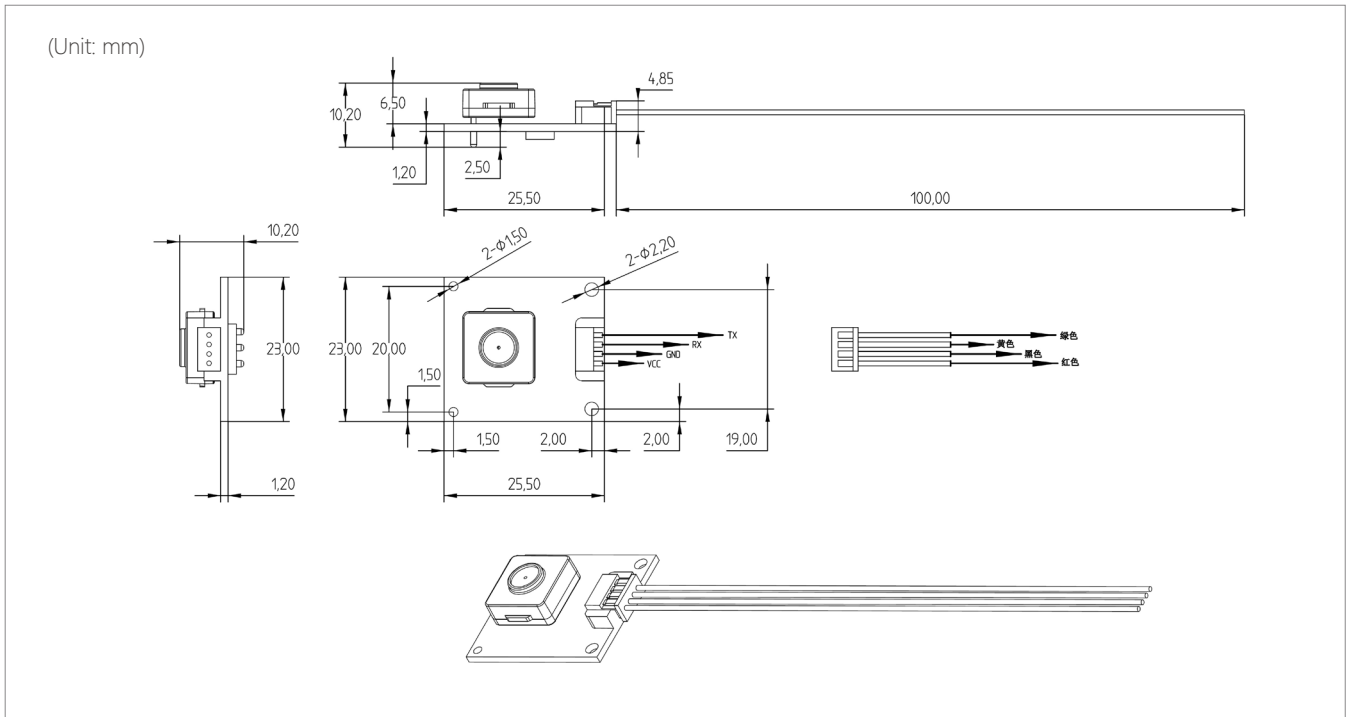

Order Information

| Product | Part Number | Range | Resolution |
|-----------------|------------------------|-----------|------------|
| TVOC Gas Module | 04-TB600C-TVOC-2000-01 | 0-2000ppm | 0.1ppm |
| 4Pin Cable | 02-MOD-CABLE-4PIN-01 | | |

Specification

| | |
|-----------------------------|--|
| Principle | Solid Polymer Electrochemical Sensing Technology |
| Order number | 04-TB600C-TVOC-2000-01 |
| Detection of gas | TVOC Organic Volatile Gases |
| Detection Range | 0 - 2000ppm; Display resolution: 0.1ppm |
| Lowest Detection Limit | 10ppm |
| Full-scale accuracy error | ±5% F.S |
| Settling time | Stored in clean air for the first time power on <120 seconds |
| | Storage in non-clean air for the first power-on <180 seconds (except in the presence of high concentrations of polluted gas) |
| Response time | <3 seconds (T50: <40 seconds; T90: <80 seconds; T100: <180 seconds;) |
| Return zero time | 1000ppm return to zero (below 5ppm) <60 seconds (return to zero in a relatively clean environment requiring ventilation) |
| | 2000ppm return to zero (below 5ppm) <120 seconds (return to zero in a relatively clean environment requiring ventilation) |
| Calibration substance | 2000ppm measurement range: 1000ppm is obutene C ₄ H ₈ gas calibration; Note: The smaller the range is, the higher the detection accuracy is. It is not recommended that users use it beyond the range. |
| Sensor life expectancy | More than three years in Relatively clean air, temperature 0-25 ° C, humidity 30-70% (Sensor life will be reduced if often exposed to corrosive gas, high temperature environment and <20% low humidity environment) |
| Indoor environment TVOC | Class I civil construction works ≤ 0.50 mg / m ³ ; Class II civil construction works ≤ 0.60 mg / m ³ |
| Relative temperature error | ± 0.2°C |
| Relative humidity error | ± 2% |
| Output | 3.3V UART digital signal (see below for communication protocol) |
| | Interface definition: VCC- red, GND- black, RX- yellow, TX- green; |
| | Baud rate: 9600 Data bits: 8 bits Stop bits: 1 bit; |
| Get data command | Communication has active upload and Q & A mode. The default mode is Q & A mode after power-on. You can use instructions to switch between the two modes. |
| | Or Q & A mode is restored by power off or switch power mode |
| | See next page for details |
| Working Voltage | 3.3 - 5.5V DC |
| Working Current | < 5mA |
| Power Consumption | 25mW @ 5V DC |
| Repeatability | Full range 2000ppm ± 1% is the normal range |
| Working temperature | 0-40°C , storage temperature -20-55°C (with temperature compensation, suitable for indoor use, if applied in outdoor or industrial environment, it is recommended that customers choose TB200B series industrial grade module -40-55°C) |
| Optimal working temperature | 20 - 35°C |
| Working humidity | 15% - 95% RH. (Non-condensing) |
| Optimum working humidity | 50% RH. |
| Working pressure | Atm ± 10% |
| Board size | 23 x 25.5X10.2mm (with sensor) |
| Board size | 23 x 25.5X4.85mm (without sensor) |
| Weight | 3.1g |
| Signal cable | The standard length is shown in the figure, and can be customized if there are special requirements. |

User Guide

Thank you for choosing EC Sense Gas module. Before using it, please read this document in detail in order to use our products correctly and effectively.

Storage

The solid-state polymer sensor can be stored for more than 1 year at a humidity of 20-95% and a temperature of -5- +30°C . Ensure that the storage environment is free of gases and substances that may contaminate the sensor. The more than 12 hours Polarization time of sensor can fully activate the electrolyte and restore the best detection state by storage time of more than half a year.

1. The best storage environment of TB600C TVOC sensor module is: temperature -5°C - +30°C , Relative humidity 25% - 95% (non-condensing);
2. The storage environment should keep the air clean, no pollution gas, no high concentration organic gas, no dust, no smoke;
3. Avoid storage with alcohol (ethanol), perfume, sodium silicate, and polyurethane liquids and solids.

Packaging and transportation

1. Avoid prolonged direct sunlight during transportation, prevent rainwater penetration;
2. Transport packaging should be protected by Shock-proof bubble film or non-odor environmentally friendly sponge;
3. During long-term long-distance transportation, the temperature in the sensor package should be kept within 40°C as much as possible, and the maximum temperature should not exceed 55°C (do not store or use at this temperature for a long time);
4. During the transportation of the finished product, seal the air inlet of the sensor as much as possible to prevent the contaminated gas from entering the sensor, which will cause the value too high or the stabilization time too long when user use the product for the first time.

Steps for usage

1. Wiring

- Perform the corresponding wiring according to the identification of the output signal port of the structure diagram. Please refer to the 4Pin signal line label in the "Structure Diagram" above. For the power supply, see the voltage and current ranges marked in the indicators.
Note: incorrect wiring will cause the module to malfunction or damage the module.

2. Stable time

- The TVOC module needs a short stabilization time after power-on. The module is designed with plug-and-play function, and usually the stabilization time is within 2 minutes. However, if the concentration of the contaminated gas is high during storage, transportation or on-site environment, the stabilization time will increase. If the on-site ambient air is highly fluid, there will be fluctuations in the data. Please pay close attention to the on-site environment status. When the environmental condition is stable and there is no strong convection and air exchange, such as opening windows, opening doors, fans, air conditioners, fresh air systems, etc., As soon as the output signal is constant, detection can begin .
- (Note: Since it is a high-precision module, the first power-on stabilization time varies under different storage and measurement environments.)
- When the module is stable, TVOC gas is usually present in normal air. Please refer to the TVOC data released by the nearest local environmental monitoring station for reference.

3. Diffusion use

- The module is used with a diffuse detection ambient gas, that is, the airflow naturally diffuses into the sensor. When the environment has a flow rate, it is necessary to ensure that the flow rate is within 500ml and that the flow rate is stable. The change of flow will cause the signal to fluctuate. When the flow is large, it will bring the change of pressure, which will cause the sensor signal value to change. The flow velocity will generate pressure, and the change in pressure will cause the output signal to change. The signal will increase when the pressure increase, And the sensor signal will change suddenly when the pressure change suddenly. Avoid negative pressure environment, which will cause physical irreparable damage to the sensor.

4. Temperature and humidity effects

- The module has been corrected for temperature compensation through an intelligent algorithm, which is suitable for the detection environment of 0-40°C . The sensor can work in the environment of -40°C -55 °C . There will be detection values in the temperature range outside the temperature compensation. The deviation is large. If you have special requirements, please contact the original factory for customization.

User Guide

- The sensor is not affected by normal humidity changes, but rapid humidity changes will cause instantaneous peak changes, mainly due to condensation on the sensor surface caused by humidity changes, which will prevent outside air from entering the sensor, but the sensor will go stable in short time. The frequent and rapid changes in temperature or humidity will affect the chemical materials and cause the sensor life to be unexpectedly reduced. Due to the principle and characteristics of electrochemical sensors, changes in the environment have different levels of influence on the chemical electrolyte inside the sensor. The EC Sense TVOC sensor module analyzes the changes of the sensor current data in detail through different environmental temperature and humidity impact tests, and combines the temperature and humidity sensor data to perform algorithmic compensation. During the use of the sensor, pay attention to the sudden changes in temperature and humidity which will cause the sensor data to fluctuate abnormally. The TVOC sensor has good adaptability to the environment. Generally, it can fully adapt to the new environment and stabilize in 5-10 minutes.
- The sensor module must not be used and stored for a long time in a high-temperature and low-humidity environment with a humidity below 10% and a temperature above 55°C. Failure to do so may result in reduced sensor life, or failure, or invalid test data.

Precautions

1. The main function of the gas sensor is to detect the gas composition and content. Please do not let any part of the sensor contact the liquid;
2. Different gas sensors have different measurement concentration ranges (ranges). Do not measure high-concentration gases for a long time during use;
3. The white or yellow sheet on the sensor is a waterproof and breathable film, please be careful not to scratch or pull it off;
4. Do not block or contaminate the surface of the sensor. Sometimes the blockage of the hole is the cause of reduced sensitivity and slow response time;
5. Please do not exchange the sensors of different gas modules. Doing so will cause measurement errors, because all the parameters of each sensor and each circuit board are matched and calibrated, and there will be deviations after the exchange;
6. Once the ES1 sensor is unplugged and re-inserted into the circuit board, please check that the three electrodes of the sensor correspond to the socket on the circuit board correctly to avoid irreversible damage to the sensor after reverse insertion;
7. Avoid excessive impact or vibration, and the case is damaged, please ensure that the structure is used without damage. If the case is damaged, please ensure that the structure is used without damage. If the case is broken and the internal structure is exposed, the output will no longer be reliable;
8. Pins must not be broken or bent. Doing so may damage the internal structure of the sensor;
9. It is slow to return to the initial state after long-term use in a high-concentration gas environment. The recovery speed is proportional to the overrange multiple;
10. When sensor detect should avoid high concentration and strong viscous gas for a long time contact with the sensor;
11. Please do not disassemble the sensor at will, it will damage the sensor;
12. Measurement range and accuracy. Select a gas sensor that matches the range and accuracy according to the actual application requirements and the gas concentration range. Otherwise, the gas may not be distinguished, accurate data may not be judged, and the sensor may be damaged;
13. When conducting on-site detection of TVOC gas, avoid the interference of other high-concentration gases on the site with TVOC, which will cause the error rate of the test results to increase.
14. Due to the principle and characteristics of the electrochemical sensor, in order to ensure the long life and the best working state of the sensor, the sensor should be kept in a continuous power state as much as possible;
15. When the TVOC module encounters high-concentration gases during use, such as TVOC gas, ethanol gas, and volatile organic gas. After the impact, the recovery time is slower. Placement in a clean air environment can shorten the recovery time.

Sensor quality inspection

1. Each sensor produced by EC Sense has a factory inspection test report, and a comprehensive performance test of the main indicators of the sensor. In the sensor manufacturing process, we will perform four index tests in different process links to screen out nonconforming products. Before the production and delivery of the material warehouse, each sensor is tested before entering the warehouse. The sensors are installed in the gas distribution test system, and full-scale standard gas is passed in for a continuous 3-5 minutes. After the test is completed, the system will automatically generate a standard sensor test report (including: serial number, sensitivity, response time T50 T90, return zero time, zero current, maximum current value) strictly in accordance with the system preset Parameter of standard qualified product. The sensors are rejected, which exceed the standards and treated as nonconforming products.

User Guide

2. All modules are calibrated with standard gas to ensure the consistency and accuracy of the sensor.

Disclaimer

EC Sense performance data stated above is based on data obtained under test conditions using EC Sense gas distribution system and AQS test software . In the interest of continuous product improvement, EC Sense reserves the right to change design features and specifications without notice. We are not responsible for any loss, injury or damage caused by this. EC Sense assumes no responsibility for any indirect loss, injury, or damage resulting from the use of this document, the information contained therein, or any omissions or errors herein. This document does not constitute an offer to sell, and the data it contains is for informational purposes only and cannot be considered a guarantee. Any use of the given data must be evaluated and determined by the user to comply with federal, state and local laws and regulations. All specifications outlined are subject to change without notice.

Warning

EC Sense sensors are designed for use in a variety of environmental conditions, but during storage, assembly, and operation, due to the principles and characteristics of solid polymer electrochemical sensors, to ensure normal use, users must strictly follow this article when using this module , And general-purpose PCB circuit board application methods, violation of the application will not be covered by the warranty. Although our products are highly reliable, we recommend that you check the module's response to the target gas before to ensure field use. At the end of the product's useful life, please do not discard any electronics in domestic waste, please follow the local government's electronic waste recycling regulations for disposal.



Sensor Production Test

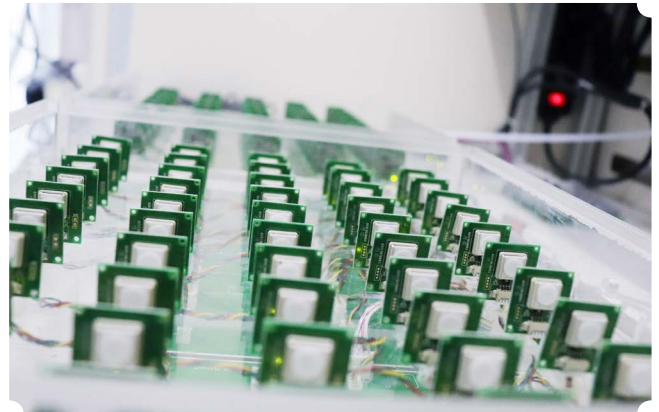

Test module, test calibration

Communication Protocol

General Settings

The sensor module uses serial communication. The communication configuration parameters are as follows:

| | |
|------------|--------|
| Baud rate | 9600 |
| Data bits | 8 bits |
| Stop bits | 1 bit |
| Parity bit | None |

Note: The communication has active upload and question-and-answer mode. The default mode is Q & A mode after power-on. You can use commands to switch between the two modes. After power-off or switch power consumption mode, the Q&A mode is restored.

Transmission mode switching instruction

Command 1 Switches to active upload. The command line format is as follows:

| 0 | 1 | 2 | 3 | 4 | 5 | 6 | 7 | 8 |
|-----------|--------|----------------|---------------|--------|--------|--------|--------|----------|
| Start bit | Retain | Switch command | Active upload | Retain | Retain | Retain | Retain | Checksum |
| 0xFF | 0x01 | 0x78 | 0x40 | 0x00 | 0x00 | 0x00 | 0x00 | 0x47 |

Note: This format is fixed

Command 2 Switch to passive upload. The command line format is as follows:

| 0 | 1 | 2 | 3 | 4 | 5 | 6 | 7 | 8 |
|-----------|--------|----------------|--------|--------|--------|--------|--------|----------|
| Start bit | Retain | Switch command | Answer | Retain | Retain | Retain | Retain | Checksum |
| 0xFF | 0x01 | 0x78 | 0x41 | 0x00 | 0x00 | 0x00 | 0x00 | 0x46 |

Note: This format is fixed

Commands in query mode

Command 3 Get the sensor type, maximum range, unit, and decimal places: 0xD1

Return value:

| 0 | 1 | 2 | 3 | 4 | 5 | 6 | 7 | 8 |
|-------------|--------------------|-------------------|------|--------|--------|--------|--|------------|
| Sensor type | Maximum range high | Maximum range low | Unit | Retain | Retain | Retain | Number of decimal places(bit[4]~bit[7]) Data sign (bit[0]~bit[3]) | Parity bit |
| 0x18 | 0x00 | 0xC8 | 0x02 | 0x00 | 0x00 | 0x00 | 0x01 | 0x35 |

Note:

Max range = (Max range high << 8) | Max range low

Unit: 0x02 (ppm and mg / m³) 0x04 (ppb and ug / m³)

Signs: 0 (positive) 1 (negative)

Decimal places: how many decimal places to read the concentration value, the maximum number of decimal places is 3

Communication Protocol

Command 4 Get the sensor type, maximum range, unit, and decimal places: 0xD7

| 0 | 1 | 2 | 3 | 4 | 5 | 6 | 7 | 8 |
|------------------|------------------|-------------|--------------------|-------------------|------|--|--------|------------|
| Command header 1 | Command header 2 | Sensor type | Maximum range high | Maximum range low | Unit | Number of decimal (bit[4]~bit[7]) Data sign (bit[0]~bit[3]) | Retain | Parity bit |
| 0xFF | 0xD7 | 0x18 | 0x00 | 0xC8 | 0x02 | 0x01 | 0x00 | 0x46 |

Description:

Checksum: Add 1 ~ 7 to generate an 8-bit data, invert each bit, add 1 at the end

Decimal places bit [4] ~ bit [7]:

$(\text{bit}[7] \ll 3) | (\text{bit}[6] \ll 2) | (\text{bit}[5] \ll 1) | \text{bit}[4]$ = number of decimal places

Data sign (bit[0]~bit[3]):

$(\text{bit}[3] \ll 3) | (\text{bit}[2] \ll 2) | (\text{bit}[1] \ll 1) | \text{bit}[0] = 0$ Negative inhibition

$(\text{bit}[3] \ll 3) | (\text{bit}[2] \ll 2) | (\text{bit}[1] \ll 1) | \text{bit}[0] = 1$ Positive inhibition

Unit :

0x02: unit is mg/m³ and ppm

0x04: unit is um/m³ and ppb

0x08: unit is 10g/m³ and %

Command 5 The format for actively reading the gas concentration value is as follows:

| 0 | 1 | 2 | 3 | 4 | 5 | 6 | 7 | 8 |
|-----------|--------|---------|--------|--------|--------|--------|--------|----------|
| Start bit | Retain | Command | Retain | Retain | Retain | Retain | Retain | Checksum |
| 0xFF | 0x01 | 0x86 | 0x00 | 0x00 | 0x00 | 0x00 | 0x00 | 0x79 |

Return value:

| 0 | 1 | 2 | 3 | 4 | 5 | 6 | 7 | 8 |
|-----------|---------|---|--|-----------------|----------------|------------------------------|-----------------------------|----------|
| Start bit | Command | High gas concentration (mg/m ³) | Low gas concentration (mg/m ³) | Full range high | Full range low | High gas concentration (ppm) | Low gas concentration (ppm) | Checksum |
| 0xFF | 0x86 | 0x00 | 0x2A | 0x00 | 0x00 | 0x00 | 0x20 | 0x30 |

Description:

Checksum: Add 1 ~ 7 digits of data to generate an 8-bit data, invert each bit, add 1 at the end.

Gas concentration value = (gas concentration high bit * 256 + gas concentration low bit) / 10^x;

x=Decimal places, The number of decimal places can be read by D1 command or D7 command

(The high and low concentrations need to be converted from hexadecimal to decimal and then brought into this formula to calculate)

Communication Protocol

Command 6 Combined reading command of gas concentration value and temperature and humidity

| 0 | 1 | 2 | 3 | 4 | 5 | 6 | 7 | 8 |
|-----------|--------|---------|--------|--------|--------|--------|--------|----------|
| Start bit | Retain | Command | Retain | Retain | Retain | Retain | Retain | Checksum |
| 0xFF | 0x01 | 0x87 | 0x00 | 0x00 | 0x00 | 0x00 | 0x00 | 0x78 |

Return value:

| 0 | 1 | 2 | 3 | 4 | 5 | 6 | 7 | 8 | 9 | 10 | 11 | 12 |
|-----------|---------|---|--|-----------------|----------------|------------------------------|-----------------------------|------------------|-----------------|---------------|--------------|------------|
| Start bit | Command | High gas concentration (mg/m ³) | Low gas concentration (mg/m ³) | Full range high | Full range low | High gas concentration (ppm) | Low gas concentration (ppm) | Temperature high | Temperature low | Humidity high | Humidity low | Parity bit |
| 0xFF | 0x87 | 0x00 | 0x2A | 0x03 | 0xE8 | 0x00 | 0x20 | 0x09 | 0xC4 | 0x13 | 0x88 | 0xDC |

Description:

Checksum: 1 ~ 11 bits of data are added to generate an 8-bit data, each bit is inverted, and 1 is added at the end.

Gas concentration value = (gas concentration high bit * 256 + gas concentration low bit) / 10^x;

x=Decimal places, The number of decimal places can be read by D1 command or D7 command

(The high and low concentrations need to be converted from hexadecimal to decimal and then brought into this formula to calculate)

Temperature is signed data with two decimal places, the unit is (°C -Celsius). Pseudo code calculation formula:

$$T = (\text{float})((\text{int})((0x0A \ll 8) | 0x09)) / 100$$

Humidity is data without sign and two decimal places, the unit is (rh%). Pseudo code calculation formula:

$$Rh = (\text{float})((\text{uint})((0x0A \ll 8) | 0x09)) / 100$$

Command 7 Get the current temperature and humidity:

Return value:

| 0 | 1 | 2 | 3 |
|------------------------|-----------------------|---------------------|--------------------|
| Temperature high 8 bit | Temperature low 8 bit | Humidity high 8 bit | Humidity low 8 bit |
| 0x0A | 0x09 | 0x11 | 0xF4 |

Description:

Temperature is signed data with two decimal places, the unit is (°C -Celsius). Pseudo code calculation formula:

$$T = (\text{float})((\text{int})((0x0A \ll 8) | 0x09)) / 100$$

Humidity is data without sign and two decimal places, the unit is (rh%). Pseudo code calculation formula:

$$Rh = (\text{float})((\text{uint})((0x0A \ll 8) | 0x09)) / 100$$

Communication Protocol

Command 8 Get the current temperature and humidity with calibration

Return value:

| 0 | 1 | 2 | 3 | 4 |
|------------------------|-----------------------|---------------------|--------------------|----------|
| Temperature high 8 bit | Temperature low 8 bit | Humidity high 8 bit | Humidity low 8 bit | Checksum |
| 0x0A | 0x09 | 0x11 | 0xF4 | 0xE8 |

Description:

Checksum: 0 ~ 3 bits of data are added to generate an 8-bit data. Each bit is inverted, plus 1 at the end.

Temperature is data with a sign and two decimal places. The unit is (°C -Celsius). Pseudo-code calculation formula:

$$T = (\text{float}(((\text{int}((0x0A \ll 8) | 0x09)))/100))$$

Humidity is data without sign and two decimal places, the unit is (rh%). pseudo code calculation formula:

$$Rh = (\text{float}(((\text{uint}((0x0A \ll 8) | 0x09)))/100))$$

Command 9 Get the current version number

Return value:

| 0 | 1 | 2 | 3 | 4 | 5 |
|------|------|------|------|------|------|
| 0x19 | 0x05 | 0x27 | 0x00 | 0x10 | 0x01 |

Data active upload mode

The upload data format is as follows:

| 0 | 1 | 2 | 3 | 4 | 5 | 6 | 7 | 8 |
|-----------|---------|---|--|-----------------|----------------|------------------------------|-----------------------------|----------|
| Start bit | Command | High gas concentration (mg/m ³) | Low gas concentration (mg/m ³) | Full range high | Full range low | High gas concentration (ppm) | Low gas concentration (ppm) | Checksum |
| 0xFF | 0x86 | 0x00 | 0x2A | 0x00 | 0x00 | 0x00 | 0x20 | 0x30 |

Note:

Checksum: 1 ~ 11 bits of data are added to generate an 8-bit data, each bit is inverted, and 1 is added at the end.

Gas concentration value = (gas concentration high bit * 256 + gas concentration low bit) / 10^x;

x=Decimal places, The number of decimal places can be read by D1 command or D7 command

(The high and low concentrations need to be converted from hexadecimal to decimal and then brought into this formula to calculate)

Communication Protocol

Low power switching

Enter sleep mode

| | | | | | |
|------|------|------|------|------|------|
| 0 | 1 | 2 | 3 | 4 | 5 |
| 0xAF | 0x53 | 0x6C | 0x65 | 0x65 | 0x70 |

Return value:

| | |
|------|------|
| 0 | 1 |
| 0x4F | 0x4B |

Exit sleep mode

| | | | | |
|------|------|------|------|------|
| 0 | 1 | 2 | 3 | 4 |
| 0xAE | 0x45 | 0x78 | 0x69 | 0x74 |

Return value:

| | |
|------|------|
| 0 | 1 |
| 0x4F | 0x4B |

Note: After exiting sleep mode, it takes 5 seconds to recover, no data within 5 seconds

0x19,0x07,0x06,0x13,0x47,0x25 Low power instructions that can be used later

Enter sleep mode

| | | | | | | |
|------|------|------|------|------|------|------|
| 0 | 1 | 2 | 3 | 4 | 5 | 6 |
| 0xA1 | 0x53 | 0x6C | 0x65 | 0x65 | 0x70 | 0x32 |

Return value:

| | | | | | | | | |
|------|------|------|------|------|------|------|------|----|
| 0 | 1 | 2 | 3 | 4 | 5 | 6 | 7 | 8 |
| 0xFF | 0xA1 | 0x00 | 0x00 | 0x00 | 0x00 | 0x00 | 0x00 | 5F |

Exit sleep mode

| | | | | | |
|------|------|------|------|------|------|
| 0 | 1 | 2 | 3 | 4 | 5 |
| 0xA2 | 0x45 | 0x78 | 0x69 | 0x74 | 0x32 |

Return value:

| | | | | | | | | |
|------|------|------|------|------|------|------|------|----|
| 0 | 1 | 2 | 3 | 4 | 5 | 6 | 7 | 8 |
| 0xFF | 0xA2 | 0x00 | 0x00 | 0x00 | 0x00 | 0x00 | 0x00 | 5E |

Communication Protocol

Turn off the running lights

| 0 | 1 | 2 | 3 | 4 | 5 | 6 | 7 | 8 |
|-----------|--------|---------|--------|--------|--------|--------|--------|----------|
| Start bit | Retain | Command | Retain | Retain | Retain | Retain | Retain | Checksum |
| 0xFF | 0x01 | 0x88 | 0x00 | 0x00 | 0x00 | 0x00 | 0x00 | 0x77 |

Return:

| 0 | 1 |
|------|------|
| 0x4F | 0x4B |

Turn on the running lights

| 0 | 1 | 2 | 3 | 4 | 5 | 6 | 7 | 8 |
|-----------|--------|---------|--------|--------|--------|--------|--------|----------|
| Start bit | Retain | Command | Retain | Retain | Retain | Retain | Retain | Checksum |
| 0xFF | 0x01 | 0x89 | 0x00 | 0x00 | 0x00 | 0x00 | 0x00 | 0x76 |

Return:

| 0 | 1 |
|------|------|
| 0x4F | 0x4B |

Query the running light status

| 0 | 1 | 2 | 3 | 4 | 5 | 6 | 7 | 8 |
|-----------|--------|---------|--------|--------|--------|--------|--------|----------|
| Start bit | Retain | Command | Retain | Retain | Retain | Retain | Retain | Checksum |
| 0xFF | 0x01 | 0x8A | 0x00 | 0x00 | 0x00 | 0x00 | 0x00 | 0x75 |

Return:

| 0 | 1 | 2 | 3 | 4 | 5 | 6 | 7 | 8 |
|-----------|---------|-------------|--------|--------|--------|--------|--------|----------|
| Start bit | Command | State value | Retain | Retain | Retain | Retain | Retain | Checksum |
| 0xFF | 0x8A | 0x01 | 0x00 | 0x00 | 0x00 | 0x00 | 0x00 | 0x75 |

Note: Status value 1 (light on), 0 (light off)

Business Centre
Europe and the rest of the world

EC Sense GmbH
Wangener Weg 3
82069 Hohenschäftlarn, Germany
Tel: +49(0)8178-99992-10 Fax: +49(0)8178-9999-211
Email: office@ecsense.com www.ecsense.com

Business Centre
Asia

Ningbo AQSystems Technology Co., Ltd.
F4-17 Buliding, Zhong Wu Technology Park No.228,
Jin Gu Bei Road, Yinzhou District NingBo,
Zhejiang Province, P.R. China Post Code: 315100
Tel: +86(0)574 88097236, 88096372
Email: info@aqsystems.cn www.ecsense.cn