



Formaldehyde Gas Sensor Module TB600C Datasheet

TB600C-HCHO-100

» Overview

The TB600C series is an intelligent digital gas sensor module using a smart microprocessor combining high-reliability solid polymer electrochemical gas sensor technology and intelligent algorithm calculation. The TB600C Gas Sensor Module is suitable for indoor and outdoor industrial applications. It detects gas, temperature and humidity and receives all data simultaneously. The data is output through the transmission command, which makes it easy and convenient to recognize the right time for maintenance and replacement. Each sensor module has been professionally calibrated with the gas, and the calibration information is stored in the flash chip. The sensor module has an I²C or a UART (TTL 3.3V) output interface, which can be easily integrated with different devices and systems.

» Key Features

- ☞ Excellent accuracy
- ☞ Detects gas, temperature and humidity
- ☞ Detects with high selectivity a wide variety of gases
- ☞ Digital signal UART (TTL 3.3V) or I²C output
- ☞ Low power consumption and sleep mode (suitable for battery and IoT applications)
- ☞ Long lifetime > 3 years
- ☞ No-poisoning
- ☞ Typical warm-up time in seconds
- ☞ Fast response time
- ☞ Linear output
- ☞ No zero line drift
- ☞ Wide temperature range of -20°C to +55°C
- ☞ No leakage
- ☞ RoHS approved

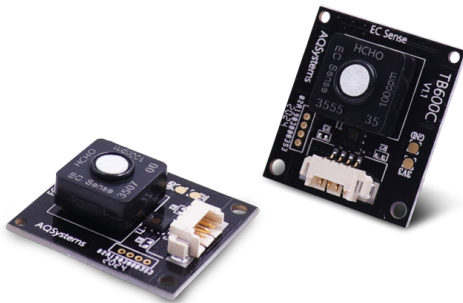

» Applications

- ☞ Industrial Safety
- ☞ Leakage Detection



» Principle

The EC Sense solid polymer electrochemical technology is a revolutionary innovation in the field of electrochemical detection. This technology is based on the principle of electrochemical catalytic reaction, detecting the output signals of the electrochemical reactions of different gases and accurately measuring the gas concentration through the signal.

The sensor is composed of three electrodes in contact with the electrolyte. A typical electrode consists of a large surface area of noble metal and other materials. The electrode, electrolyte and the surrounding air are in contact and the gas diffuses into the working electrode. Here the gas will be oxidized, this causes a current, which is proportional to the gas concentration.

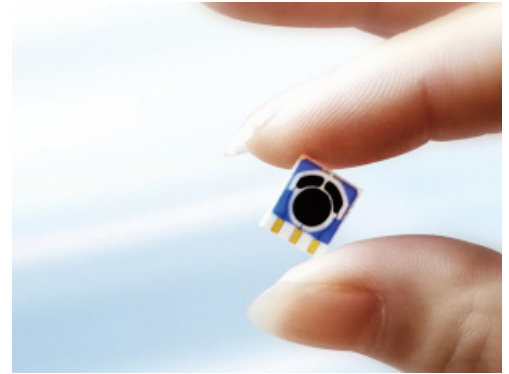

» Mechanical Drawing

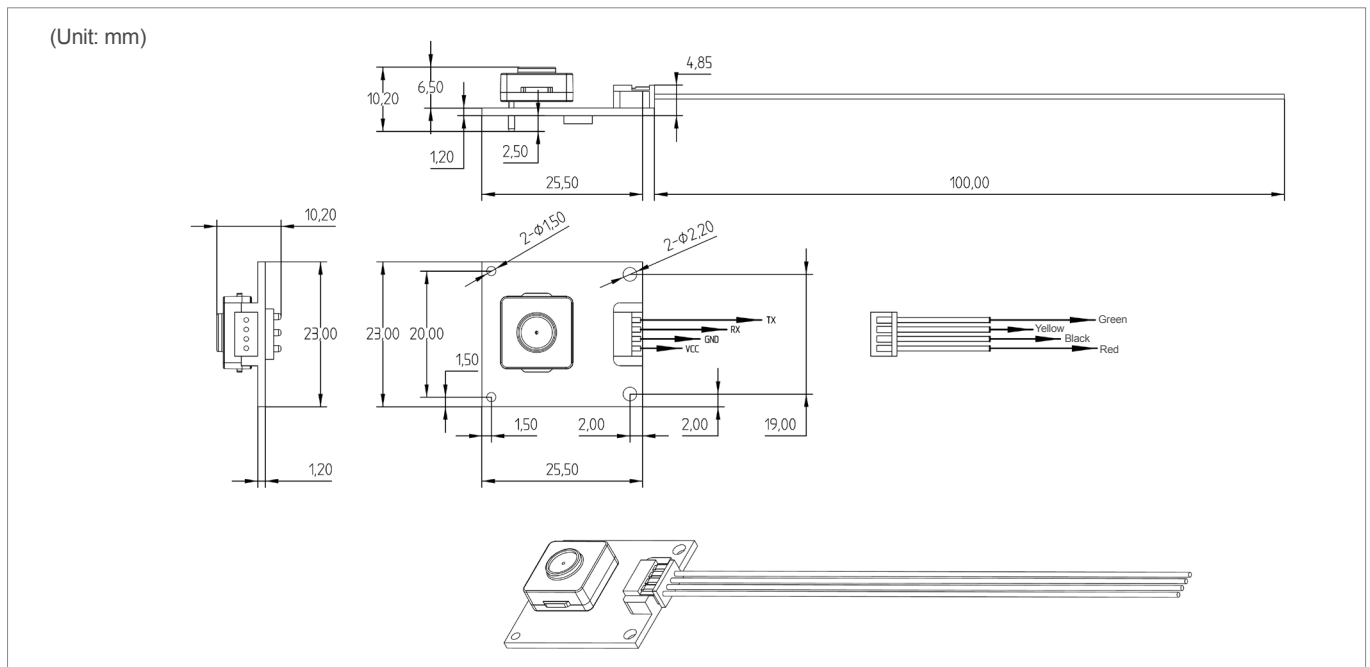

» Order Information

Product	Partnumber	Range	Resolution	Output
Formaldehyde Gas Sensor Module	04-TB600C-HCHO-100-01	0-100ppm	0.1ppm	UART TTL 3.3V
	04-TB600C-HCHO-100-I2C-01	0-100ppm	0.1ppm	I ² C
4Pin Cable	02-MOD-CABLE-4PIN-01			

» Technology Specifications

Gas Sensor Specifications

Principle	Solid Polymer Electrochemical Sensing Technology
Detection Gas	Formaldehyde Gas
Response Time	< 3 seconds (T50: < 20 seconds; T90: < 120 seconds)
Accuracy	< 5% F.S
Repeatability	Full range ± 1% is the normal range
Linearity	Linear
Long-Term Drift	< 1% / month
Expected Lifetime	> 3 years

Temperature & Relative Humidity Sensor Specification

Temperature Range	-20°C to +70°C
Temperature Accuracy	± 0.2°C (Typical Value)
Humidity Range	0 to 100% RH
Humidity Accuracy	± 2% (Typical Value)

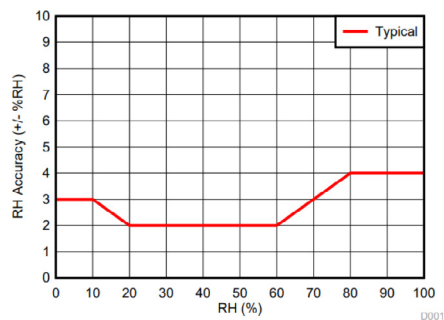
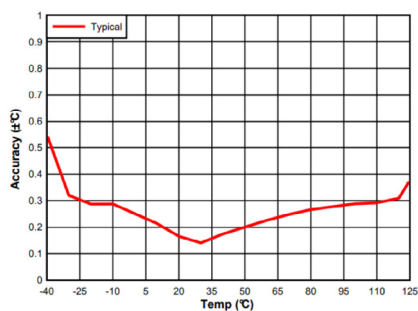

Environment Specifications

Working Temperature	-20°C to +55°C
Working Humidity	15% - 95% RH. (Non-condensing)
Working Pressure	Atmospheric pressure ± 10%

Mechanical Specifications

Size (Including gas sensor)	23 x 25.5 x 10.2mm
Size (Without gas sensor)	23 x 25.5 x 4.85mm
Weight	3.1 g
Warranty	12 months from the date of shipment
Signal Cable	The standard length is shown in the structure diagram and can be customized if there are special requirements.

» Technology Specifications

Electrical Specifications

Output Signal	UART TTL 3.3V or I ² C digital signal, for more information please see "Communication Protocol"
	UART Interface definition: VCC- red, GND- black, RX- yellow, TX- green
	UART Baud rate: 9600 Data bits: 8 bits Stop bits: 1 bit
	I ² C Interface definition: VCC-red, GND-black, SDA-yellow, SCL-green
I ² C Frequency: ≤ 20kHz I ² C Signal Voltage: 3.3V	

UART TTL 3.3V

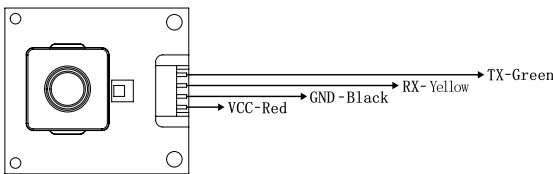

I²C 3.3V

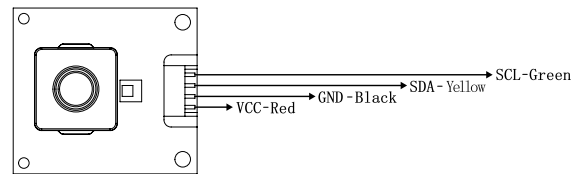

Get Data Command	Communication has active upload and Q&A mode. The default mode is Q&A mode after power-on. You can use instructions to switch between the two modes. Note: If you switch off the module or switch to sleep mode, the module remains in Q&A mode.
Supply Voltage	3.3 to 5.5V DC, Recommended 5V DC
Supply Current	9.5mA @ 5VDC
Current (Switch off LED lamp)	8.7mA @ 5VDC
Peak Current	11mA @ 5V DC
Sleep Mode Current	0.85mA @ 5V DC
Power Consumption	40mW @ 5V DC
Working Current	< 5mA
Sleep Mode Power Consumption	25mW @ 5V DC

Certifications

RoHS Certification No.A2230090158101001

Disclaimer

The EC Sense performance data stated above is based on data obtained under test conditions using the EC Sense gas distribution system and AQS test software. In the interest of continuous product improvement, EC Sense reserves the right to change design features and specifications without notice. We are not responsible for any loss, injury or damage caused by this. EC Sense assumes no responsibility for any indirect loss, injury or damage resulting from the use of this document, the information contained therein or any omissions or errors herein. This document does not constitute an offer to sell. The data it contains are for informational purposes only and cannot be considered a guarantee. Any use of the given data must be evaluated and determined by the user to comply with federal, state and local laws and regulations. All specifications outlined are subject to change without notice.

Warning

EC Sense sensors are designed for use in a variety of environmental conditions. However, due to the principles and characteristics of solid polymer electrochemical sensors and to ensure normal use, users must strictly follow this article during storage, assembly and operation of the module. Avoid cleaning the sensors with alcohol, acetone or other strong solvents. General-purpose PCB circuit board application methods and illegal applications / violation of the application will not be covered by the warranty. Although our products are highly reliable, we recommend checking the module's response to the target gas prior to utilization to ensure on-site use. At the end of the product's service life, please do not discard any electronics in the domestic waste, instead follow the local governments electronic waste recycling regulations for disposal.



**Business Centre
Europe and the rest of the world**

EC Sense GmbH
Wangener Weg 3
82069 Hohenschäftlarn, Germany
Tel: +49(0)8178-9999-210 Fax: +49(0)8178-9999-211
Email: office@ecsense.com
www.ecsense.com, www.ecnose.de

**Business Centre
Asia**

Ningbo AQSystems Technology Co., Ltd.
F4-17 Building, Zhong Wu Technology Park No.228,
Jin Gu Bei Road, Yinzhou District NingBo,
Zhejiang Province, P.R. China Post Code: 315100
Tel: +86(0)574 88097236, 88096372
Email: info@aqsystems.cn
www.ecsense.cn, www.ecnose.de